

Important information!

Optimal load securing...

...with **VIP** and
ICE-Lashing means

Best load securing –
a compulsory
legal necessity!

ICE[®]
120



Edition 21



Professional hints for a safe road transport!

To avoid sliding...

...best load securing
– a compulsory legal
necessity acc.
EN 12195-1;2;3;4.

Every person responsible for low loaders, lorries or other transport vehicles, which has either sometimes or permanently to transport goods of any kind, should carefully read the following instructions because they help avoiding accidents, considerable costs and perhaps prosecution.

This also addresses those "casual transporters" who normally use their lorries for the transport of excavated earth or grit and are just sometimes driving with their low loaders or transport part loads on the lorry platform.

Just amongst those persons, an increased thoughtlessness and ignorance concerning the physical- and legal correlations can be found as compared with experts.

*Dipl.-Wirt.-Ing (FH) Alexander Hoffmann
Dipl.-Ing. (FH) Reinhard Smetz
Dipl.-Ing. (FH) Michael Betzler*



You should not wait until an accident has happened to think about a correct load securing. In many cases, the forces occurring during driving are underestimated and the strength of the lashing systems used is overestimated.

Hint for the new EN 12195-1:2010:

The EN 12195-1: 2010 is contradictory to the results of many academic and by practical confirmed tests.

The status of an accepted technical regulation is doubtful.

To guarantee a sufficient safety level, the following statements refer to the EN 12195-1:2003 resp. to the VDI 2700 ff.

For every transport it is compulsory to stow the load as well as lashing chains, devices and other load securing systems in a traffic-safe way and to secure them especially against falling down and noise development; this means to secure the load in such a way that it cannot move.

The fact that a movement of loads is not only realistic with slight loads, is proven by manifold photos of accidents as well as frequent announcements in the media or radio traffic service on accidents caused by lost loads.

It has, however, to be urgently warned of an intuitive load securing as physics has its own inconvertible laws. Only by concrete calculations, the actual forces affecting the load can be demonstrated.

Based upon two practical examples, we want to try to enlighten the "physics of lashing". The calculations have been built up in such a way that they can also be understood without an engineer's or technical study and can be an aid for future calculations. For more detailed calculations, please refer to the VDI 2700-2 "lashing forces" or the EN 12195-1.

Basically it is binding that with a full braking, the 0.8fold of the load weight presses in direction of the driver's cabin; with a cornering and when starting, half of the load weight presses in direction of the platform gates. This means in figures, based upon an example: With a load weight of $m = 10000 \text{ kg}$, $8000 \text{ kg} \approx 8000 \text{ daN}$ are pushing in direction of the driver's cabin. When starting or cornering, $5000 \text{ kg} \approx 5000 \text{ daN}$ are pushing against the platform gates.

These forces have to be safely compensated by corresponding lashing systems. In general, two different ways of lashing may occur:

- vertical lashing
- direct lashing

thereby dividing the direct lashing in:

- inclined lashing
- diagonal lashing

Vertical lashing

Vertical lashing is the lashing method mostly used with goods transport on roads, since most of the loads are so broad that a securing can only be realised by a vertical lashing. For a vertical lashing, the following prerequisites have to be adhered to in all cases:

- A high friction between load and loading platform as well as between stacked load units have to be assured. The **sliding coefficient of friction μ** has to be known.
- The vertical angle α should reach 90° if possible. It has to be known.
- The load must withstand an increased pre-tensioning.
- The lashing points must be suitable for the loading.
- The value of the required pre-tensioning force put in with the tensioning element and being the most important factor, must be known.

This highlights the disadvantages and the limits of the vertical lashing: with this kind of lashing, the lashing means, the lashing points and the load itself are permanently submitted to a high pulling force. In general, the vertical lashing can only be realised if there exists a sufficient friction coefficient between loading platform and load, as already mentioned. For example, steel to steel is very unfavourable; thus chocks or FIMs (friction increasing material) are used for increasing the friction. The loading platform and the load itself have to be free from oil, dirt and ice.

How is the securing effect with vertical lashing produced?

When applying the **total pre-tensioning force F_V** to the lashing means (lashing chain, lashing belt) by tensioning elements (spindle tensioner, ratchet), the friction force F_R is increased. The effective friction force is composed by the part resulting of the load weight $G \times \mu$ and the part of the vertical force component of the actually applied pre-tension force with $F_V \times \sin \alpha \times \mu$. Both values together have to be bigger than the force by which the load tries to move on the loading platform, thus the 0.8fold or 0.5fold of the load weight:

$$c_{x,y} \times G < G \times \mu + F_V \times \mu \times \sin \alpha$$

For the required total pre-tension force F_V , the following formula applies:

$$F_V = \frac{G \times (c_{x,y} - \mu)}{\mu \times \sin \alpha}$$

Thereby meaning:

G = weight force in daN $\approx m$
= mass in kg

$c_{x,y}$: Acceleration factor

c_x : Acceleration factor
in driving direction = 0.8
contrary to driving direction = 0.5

c_y : Acceleration factor transverse
to driving direction = 0.5

μ : sliding coefficient of friction

α : vertical angle (angle between
loading platform
and chain strand)

Calculation example 1:

Load: concrete part
 $m = 4000 \text{ kg} \approx 4000 \text{ daN} = G$

Concrete/wooden loading platform,
 $\mu = 0.3$

Vertical angle $\alpha = 60^\circ$

For the example, a lashing chain type ICE-VSK-8 with a STF of 2800 daN has been chosen out of the table on page 22.

$$n = \frac{7698 \text{ daN}}{2800 \text{ daN} \times 1.5} = 1.8 \text{ chosen } 2$$

In addition, all required tests regarding the replacement criterias of the chain can easily be carried out by means of these identification tags.

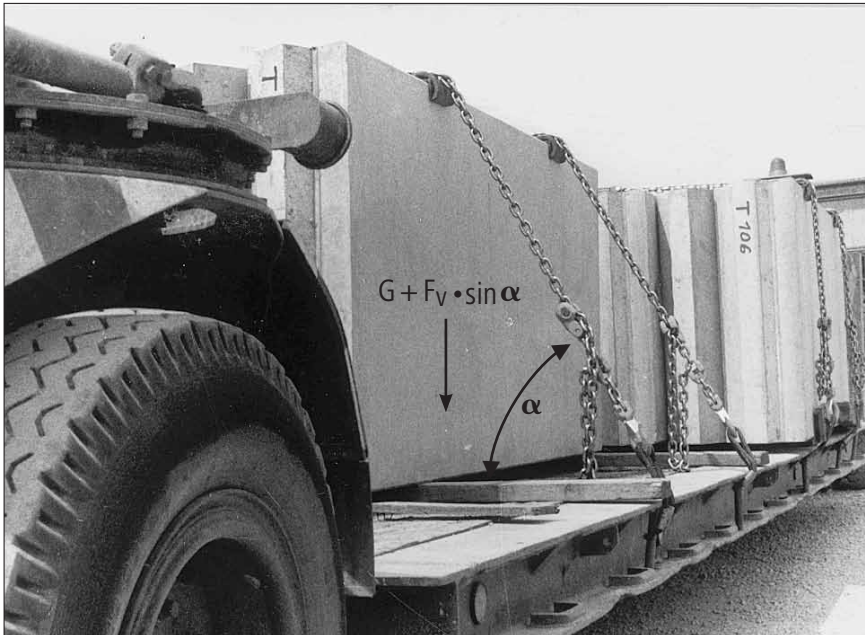

The basic idea of a vertical lashing is to increase the natural load by applying pre-tension forces and thus to increase the friction force avoiding a movement of the load.

$$F_v = \frac{G \times (c_{x,y} - \mu)}{\mu \times \sin \alpha} \text{ (daN)}$$

$\sin 60^\circ = 0.866$

$$F_v = \frac{4000 \text{ daN} \times (0.8 - 0.3)}{0.3 \times 0.866}$$

$F_v = 7698 \text{ daN}$
 Total pre-tension force

Thus, the **number of the required loops n** can be calculated with the following formula:

$$n = \frac{F_v}{STF \times 1.5}$$

Meaning:
 STF = Standard tension force (the pre-tension force obtainable by a tensioning element).

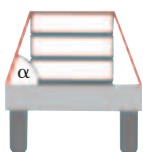

Two looped lashing chains of the above mentioned type are required.

Attention:

On the patented ICE/VIP identification tag of RUD (surface galvanised), the following indications have to be distinguished:

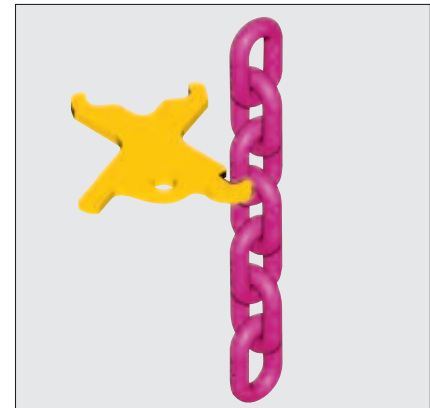
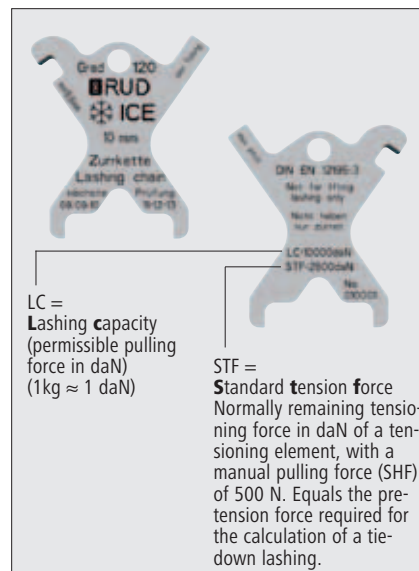

Testing wear of nominal diameter

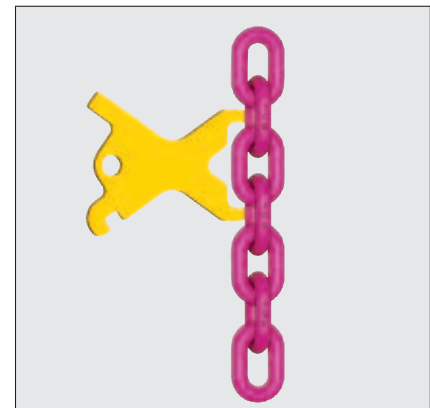

Testing plastic elongation caused by overload

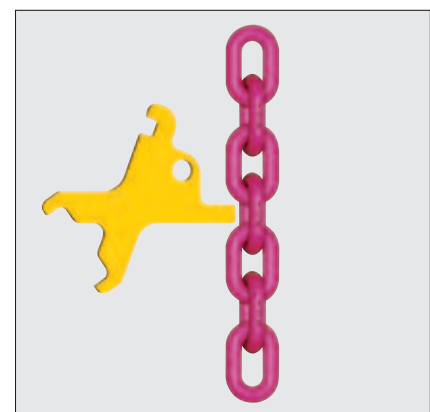

Testing elongation of pitch caused by wear of nominal diameter

Diagonal lashing

In general the diagonal lashing has to be given preference to a vertical lashing as no special static pre-tension forces have to be applied. The lashing means/lashing points have only be provided with a slight pre-tension, contrary to the vertical lashing. The lashing means are only loaded in case of increased forces occur as a result of braking, starting of intensive cornering.

With a diagonal lashing, the following particularities have to be respected in all cases:

The arrangement and position of the lashing strands with respect to the corresponding load directions is very important.

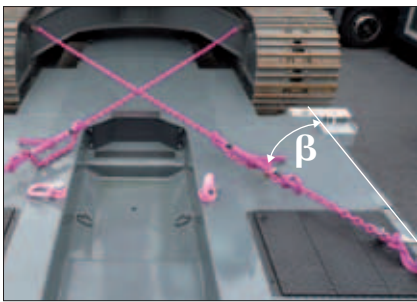

Horizontal angle β

RUD Ketten offers a calculation aid easy to handle with angle measuring device, facilitating the determination of the angles α and β .

By means of the calculation aid, the correct lashing chain can very quickly be chosen (refer to page 11).

By the examples of calculations it will be obvious that the angle β has possibly to be fixed between 20° and 45°.

If β becomes very small, the lashing means will be submitted to an extreme load with curve driving.

If β becomes very big, this will result in an extreme load in case of braking/accelerating.

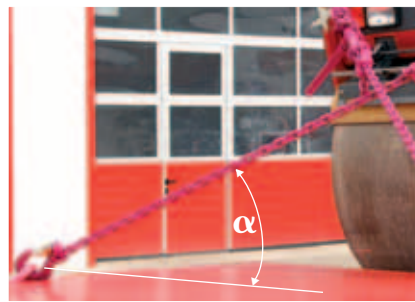

Vertical angle α

For a diagonal lashing, however, 2 angle positions (horizontal and vertical) have to be considered and thus, two angle definitions have to be realised.

The two photos above shall facilitate a clear definition of the angles to be considered.

The angles α and β play a decisive role for the calculation. The angle β is the horizontal angle between an imaginary straight line in driving direction and the chain strand. The vertical angle α is the angle between loading platform and the chain strand.

In an extreme case with angle $\beta = 90^\circ$ this would mean that theoretically, an infinite force would occur in the lashing means. This example shall clearly reveal that an extreme cross-wise lashing as securing in driving direction - as often shown at big machines like earth moving machineries - is the most unfavourable way of load securing in driving direction.

Concerning the angle α , the optimal lashing effect is between 0° and 30°. With increasing α , the load of the lashing means increases at the same time, with an angle of 90° theoretically infinitely.

Calculation example 2:

Excavator

$m = 18000 \text{ kg} \approx 18000 \text{ daN} = G$

Vertical angle of the lashing strands:

$\alpha = 10^\circ$

Horizontal angle of the lashing strands:

$\beta = 40^\circ$

Number of the effective lashing chains in the relevant direction:

$n = 2$

Friction coefficient μ with a dirty/icy wooden loading platform:

$\mu = 0$

The friction coefficient μ of the excavator on the dirty wooden loading platform will be neglected and not considered with the first calculation.

The formula for the required lashing means with the **permissible pulling force = LC = Lashing capacity** being as follows:

$$LC = \frac{G \text{ (daN)} \times C_x}{\cos \alpha \times \cos \beta \times n} \text{ (daN)}$$

$\cos 10^\circ = 0.984$

$\cos 40^\circ = 0.766$

C_x : Acceleration factor
in driving direction = 0.8
contrary to driving direction = 0.5

$$LC = \frac{18000 \text{ daN} \times 0.8}{0.984 \times 0.766 \times 2}$$

LC = 9550 daN

For the excavator with a weight of 18000 kg \approx 18000 daN and the lashing arrangement shown, a lashing mean has to be chosen possessing at least the permissible pulling force of 9550 daN.

According to the table on page 22, this would be the type ICE-VSK-10, nominal size 10.

Calculation example 3:

The same example shall be shown again, however, with angles α and β , being most unfavourable, i.e., same as with a cross lashing, whereby angle $\beta = 80^\circ$ and $\alpha = 75^\circ$.

All other values remain the same.

$$\begin{aligned} \cos 75^\circ &= 0.258 \\ \cos 80^\circ &= 0.173 \end{aligned}$$

$$LC = \frac{18000 \text{ daN} \times 0.8}{0.258 \times 0.173 \times 2}$$

$$LC = 161,312 \text{ daN!!!}$$

This calculation shows in an especially clear way how important the angles are for the calculations and that with unfavourable angles, a load securing would become illusory.

If with a diagonal lashing, the friction coefficient becomes $\mu < 0.5$, a re-calculation in terms of curve driving has to be realised. The formula being as follows:

$$LC = \frac{G \text{ (daN)} \times C_y}{\cos \alpha \times \sin \beta \times n} \text{ (daN)}$$

C_y = Acceleration factor transverse to driving direction = 0.5

This formula only distinguishes by a different factor with curve driving of 0.5 and the $\sin \beta$ occurring with lateral direction.

Calculation example 4:

Example 2 shall be shown again, however, with favourable weather conditions and with clean loads, loading platforms and the use of friction increasing material.

The increased friction factor μ can affect the calculation positively.

In/contra to driving direction:

$$LC = \frac{G \text{ (daN)} \times (c_x - \mu)}{(\sin \alpha \times \mu + \cos \alpha \times \cos \beta) \times n} \text{ (daN)}$$

$$G = 18000 \text{ daN}$$

$$\mu = 0.5$$

$$\cos \alpha = \cos 10^\circ = 0.984$$

$$\cos \beta = \cos 40^\circ = 0.766$$

$$\sin \alpha = \sin 10^\circ = 0.173$$

$$LC = \frac{18000 \text{ daN} \times (0.8 - 0.5)}{(\sin 10^\circ \times 0.5 + \cos 10^\circ \times \cos 40^\circ) \times 2}$$

$$LC = \frac{18000 \text{ daN} \times (0.8 - 0.5)}{(0.173 \times 0.5 + 0.984 \times 0.766) \times 2}$$

Laterally to driving direction:

$$LC = \frac{G \text{ (daN)} \times (c_y - \mu)}{(\sin \alpha \times \mu + \cos \alpha \times \sin \beta) \times n} \text{ (daN)}$$

$$= 3210 \text{ daN per lashing strand}$$

According to the table on page 22, this would be the type ICE-VSK-8, nominal size 8.

In order to safely accept the relatively high permissible pulling forces, shown in calculation example 2, for the first time the "Verein Deutscher Ingenieure" (VDI = association of German Engineers) issued guidelines fixing clear minimum requirements with regards to quality, permissible pulling force, minimum breaking force, identification and much more. This guideline was named VDI 2701 "Lashing means, load securing on road vehicles" and has been valid since January 1985; it could also be considered as state of the art at court. With some modifications, this guideline has been adapted to the European standard EN 12195-3 and has legally been binding since June 2001.

Based upon these rules, a lot of common lashing chains, especially those with ratchet tensioners having a long lever arm and with no turn-out securing device, originating from the Far East, are no longer acceptable. Furthermore, most of the shortening elements (chain killers) do in no way fulfil the requirement, that by their

use, no reduction of the breaking strength must occur.

In the prescribed identification tags, the pre-tension forces obtained by the tensioning elements STF - Standard tension force have to be mentioned; these are not allowed to exceed the values of 0.5 LC (Lashing capacity, permissible pulling force). For detailed requirements of the standard, please refer to the table on pages 26/27.

In this standard, grade 8 is mentioned as highest quality class of chains. Meanwhile, there are existing, however, grade 10 and even 12 showing considerable improvements with regards to pulling force, fulfilling all requirements of EN 12195-3 and even exceeding them.

Selection of the right lashing mean

Concerning the afore-mentioned calculation example 2, at a minimum permissible pulling force LC of 9550 daN, a lashing chain 13 of grade 8 would be used. The standard version has a length of 3.5 metre, the chain link diameter is 13 mm. The permissible pulling force is 10,000 daN.

The example clearly shows the advantage of the ICE lashing chain generation.

For a required permissible pulling force of 9550 daN, an ICE lashing chain of type ICE-VSK-10 would suffice.

The length of the ICE standard version is 3.5 metre, too, however, the chain diameter is only 10 mm. The permissible pulling force LC amounts 10,000 daN, too. The weight of the standard chain of grade 8 is nearly 70 % higher than a grade **ICE-120**.

The table on pages 26/27 shows the improvements of the ICE quality compared with the EN standard. The clever calculators will recognise very quickly that the higher purchase prices will soon be compensated by the long-life and robust ICE chains with their easier handling.

By using these pink-coloured lashing chains you will easier satisfy the critical eyes of the controlling authorities (avoids press charges).

The elastic elongation of the lashing chains with a permissible pulling force LC (half of the minimum breaking force) is only 1.1 up to 1.6 % compared with the new lashing belts < 7 %. This low elongation can be of big advantage when having long lashing means.

The first calculation example has shown that for a safe vertical lashing (see page 4), the amount of the pre-tension force has to be known in all cases. This pre-tension force, however, is the big unknown. Furthermore, the driver is not able to recognise a decrease of the pre-tension force, caused by settling of the load during driving. This will result again and again in uncontrolled lashing forces questioning the effectiveness of the load securing. Referring to the calculation example 1 (see page 4) - vertical lashing- in theory 11 looped lashing belts should have been used at a required total pre-tension force $F_v = 7698$ daN and a STF of 500 daN.

With a loop, theoretically enabling a doubling of the pre-tension force, it cannot not be assured by 100 % that on the side opposite the ratchet there exists the same pre-tension force. By friction losses at the corners of the loop the pre-tension force can be considerably reduced. These losses may be reduced to a certain extent by edge protection devices; however, the safest way to absolutely avoid any losses is either the use of two tensioning elements (one element per side) or, as mentioned in the formula on page 4 at the bottom left, to increase the number of lashing means by factor 1.5.

Thanks to high pre-tension force STF RUD lashing chains are also ideal for vertical lashing!



The RUD Lashing Card

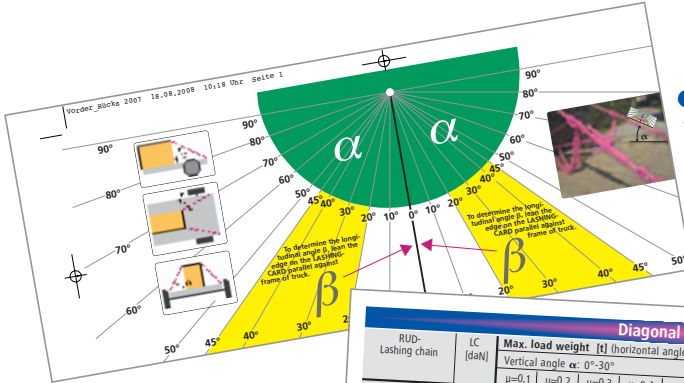

● Angle measuring device for specifying vertical angle α and horizontal angle β

● Collection of tables for selecting of the correct VIP- or ICE chain for vertical- or diagonal lashing.

		Diagonal lashing											
RUD-Lashing chain	LC [daN]	Max. load weight [t] (horizontal angle β : 20°-45°; 2 lashing chains per direction)											
		Vertical angle α : 0°-30°				Vertical angle α : 30°-60°				Vertical angle α : 60°-90°			
		$\mu=0,1$	$\mu=0,2$	$\mu=0,3$	$\mu=0,4$	$\mu=0,5$	$\mu=0,6$	$\mu=0,1$	$\mu=0,2$	$\mu=0,3$	$\mu=0,4$	$\mu=0,5$	$\mu=0,6$
VIP-VSK 6	3000	5,2	7,0	8,7	10,9	14,5	21,9	3,8	5,3	7,5	10,7	16,0	26,7
VIP-VSK 8	5000	8,7	11,7	14,5	18,2	24,3	36,5	6,4	8,9	12,5	17,8	26,7	44,5
ICE-VSK 8	6000	10,5	14,0	17,4	21,8	29,1	43,9	7,6	10,7	15,0	21,4	31,0	53,4
VIP-VSK 10	8000	14,0	18,7	23,2	29,1	38,9	58,5	10,2	14,3	20,0	28,5	42,7	71,2
ICE-VSK 10	10000	17,5	23,4	29,0	36,4	48,6	73,1	12,8	17,9	25,0	35,6	53,4	89,0
VIP-VSK 13	13400	23,4	31,4	38,9	48,7	65,2	98,0	17,1	23,9	33,5	47,8	71,6	119,3
ICE-VSK 13	16000	28,0	37,5	46,4	58,2	77,8	117,0	20,5	28,6	40,0	57,1	85,5	142,4
VIP-VSK 16	20000	35,0	46,9	58,1	72,8	97,3	146,3	25,6	35,8	50,0	71,3	106,9	178,0

		Frictional lashing											
RUD-Lashing chain	STF [daN]	required number of VIP + ICE lashing chains (number of lashing chains = factor from table X load weight [t])											
		Vertical angle α : 60°-90°				Vertical angle α : 30°-60°				Vertical angle α : 0°-30°			
		$\mu=0,1$	$\mu=0,2$	$\mu=0,3$	$\mu=0,4$	$\mu=0,5$	$\mu=0,6$	$\mu=0,1$	$\mu=0,2$	$\mu=0,3$	$\mu=0,4$	$\mu=0,5$	$\mu=0,6$
VIP-VSK 6	1500	3,6 x	1,6 x	0,9 x	0,6 x	0,4 x	0,2 x	6,3 x	2,7 x	1,5 x	0,9 x	0,6 x	0,3 x
VIP-VSK 8	2500	2,2 x	1,0 x	0,6 x	0,4 x	0,2 x	0,2 x	3,8 x	1,6 x	0,9 x	0,6 x	0,4 x	0,2 x
VIP-VSK 10	2800	2,0 x	0,9 x	0,5 x	0,3 x	0,2 x	0,1 x	3,4 x	1,5 x	0,8 x	0,5 x	0,3 x	0,2 x
ICE-VSK 8/10/13	2800	2,0 x	0,9 x	0,5 x	0,3 x	0,2 x	0,1 x	3,4 x	1,5 x	0,8 x	0,5 x	0,3 x	0,2 x
VIP-VSK 13/16	3600	1,5 x	0,7 x	0,4 x	0,3 x	0,2 x	0,1 x	2,6 x	1,2 x	0,7 x	0,4 x	0,3 x	0,2 x

RUD Lashing-Card
Load securing on road vehicles according to EN 12195-1:2003

Slide-coefficient of friction μ according to VDI 2700-2

Materials	dry	wet	greasy
Wood/wood	0,20-0,50	0,20-0,25	0,05-0,15
Metal/wood	0,20-0,50	0,20-0,25	0,02-0,10
Metal/metal	0,10-0,25	0,10-0,20	0,01-0,10

More information under: www.rud.com

Values of both tables refer to: stable load, road transport, no combined load securing!

Order now by using number 7997579

RUD ID System – The innovative identification system for lashing and lifting means

The RUD-ID-SYSTEM® is a reliable digital assistance regarding inspection and administration of lashing and lifting means. It bases upon the RFID technology. The system consists of transponder, reader and a web-based administration software.

The transponder RUD-ID-Point® is captively embedded into the provided borehole of the tensioner (patent); it can be read contactless via the reader RUD-ID-EASY-CHECK®.

The RUD-ID-Point® is extremely resistant against temperature, impacts, pollution, water, acid, magnetic fields. It contains a worldwide distinctive, unchangeable, 16-digit identification number. The robust RUD-ID-EASY-CHECK® readers capture the identification number of the RUD-ID-Point® and transfer it to the RUD-ID-NET® application (software), resp. optionally to your PC application like WordPad, MS Word, MS Excel, SAP etc.

The RUD-ID-SYSTEM® features many simplifications:

- Digital maintenance, analysis, administration of inspection datas
- ✂ efficient inspection procedure
- ✂ automatic inspection reminder
- ✂ automated inspection reports
- Digital connection to current product information and documents with access to the RUD web portal with its considerably applications like e.g. lashing calculation.

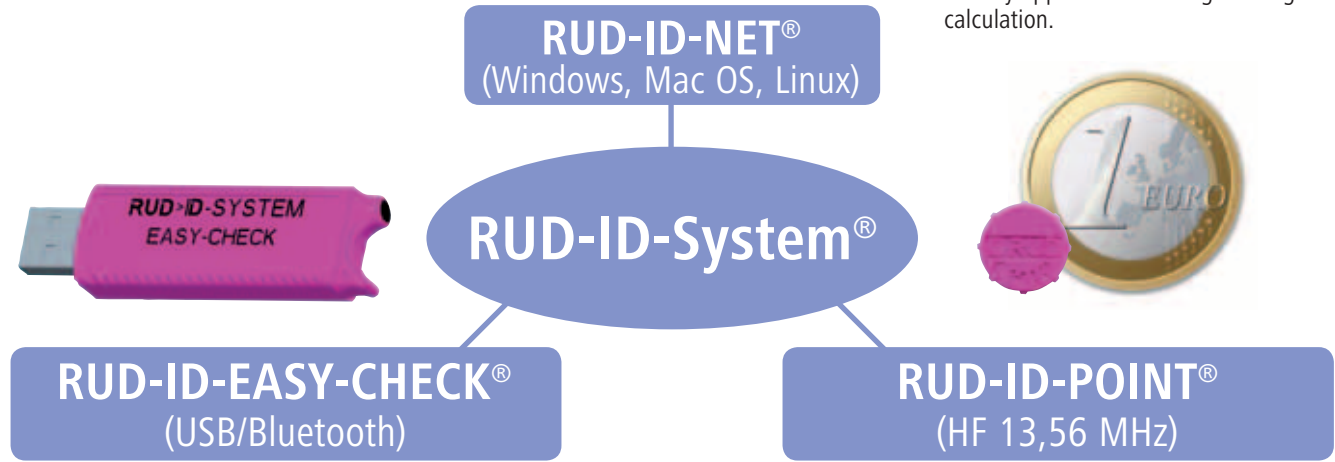

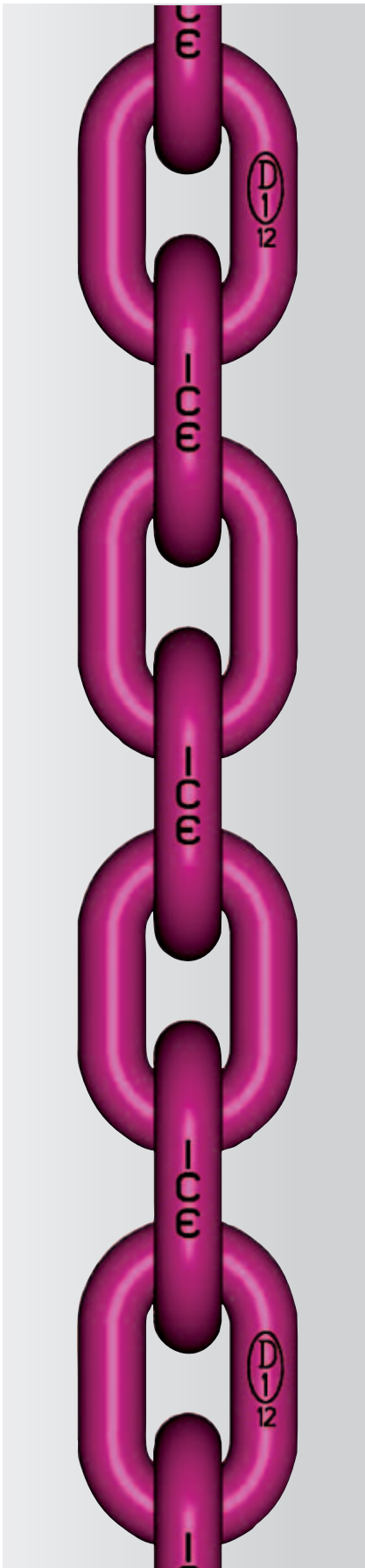

Latest state of chain technology

RUD Ketten from Aalen, Baden Württemberg, launched as first chain manufacturer in 1994 the grade 10 under the name VIP-100 in an eye-catching pink powder coating.

This chain quality quite new at that time revolutionized the chain market, since it could be loaded by up to 30 % more, using the same nominal size.

This resulted in a considerable saving of weight and improvement of ergonomics compared to grade 8 still widely common today.

Improved again – ICE line for load securing

13 years after the triumphal procession of grade VIP-100, RUD made the next innovation step in chain technology.

As world wide first manufacturer, RUD received approval for **round steel link chains in grade 12** by the German BG to stamp "D".

Compared with the common grade 8, this special quality class does have a **breaking strength up to 60 % higher!** For lashing technique this means a LC (Lashing Capacity = permissible lashing force) increase by up to 60 %.

Further technological features such as:

- Breaking elongation and ductility
- Deep temperature toughness
- Crack growth resistance
- Fatigue strength and wear resistance

could also be considerably be improved.

The enormous toughness with low temperatures of more than - 60°C finally inspired for the name of this chain generation: **ICE-120**. The Colour was chosen in ICE-Pink (purple), thus guaranteeing a clear differentiation between the red of grade 8 and pink (magenta) of grade VIP-100, however, still maintaining the Pink Family of the RUD identification colour.

Ultra-light – up to 45 % reduction of weight!

Nominal size [mm]	Lashing Capacity LC [daN]	
	Grade 8	ICE
6	2.200	–
8	4.000	6.000
10	6.300	10.000
13	10.000	16.000
16	16.000	–

ICE lashing chain replaces grade 8 of the next bigger nominal size

ICE lashing chains

Due to the tremendous strength of the patented ICE material, a continuous leap in the nominal size could be realised for the first time compared with grade 8 even with smaller dimensions than a diameter of 16 mm; this means, for direct lashing, an ICE lashing chain, is able to replace a lashing chain of grade 8 of the next bigger nominal size.

The result:

Up to 45 % reduction of weight!

The approved technical advantages of the VIP program were maintained with the ICE lashing chain and further developed.

Tensioning-, connecting- and shortening elements were considerably improved in terms of weight and functionality.

As a special highlight the tensioner **ICE-CURT** shows many advantages. It

- exceeds the requirements of EN 12195-3,
- has a patented preparation for theft protection via padlock (Type ABUS 85/40HB),
- is equipped with a **RUD-ID-POINT®**
- is easy to clean and lubricate,
- has a novel, convenient anti-loosening device,
- is easy and quick to handle – even with gloves,
- is extra light and robust – thanks to its innovative forging construction.

By using ICE lashing chains, the user has less weight to carry and lift, improved ergonomics, faster mounting possibilities and increased safety.

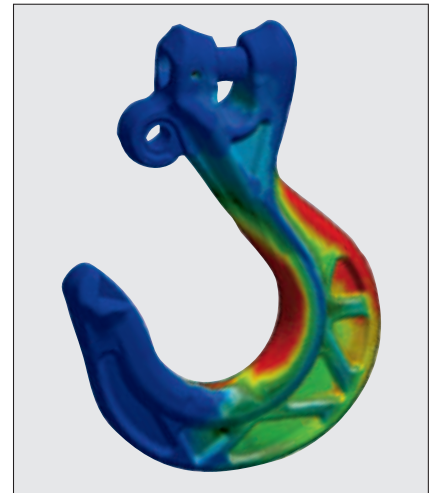
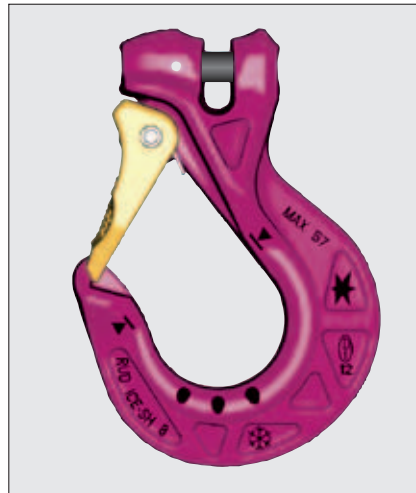

The ICE-STAR-HOOK in FEM weight-optimized design is up to 25 % lighter than a hook in grade 8 of the next bigger chain despite a big hook mouth width.

The magnetic sticking securing disc of the ICE-CURT prevents unintended loosening.



Securing disc open



Securing disc closed

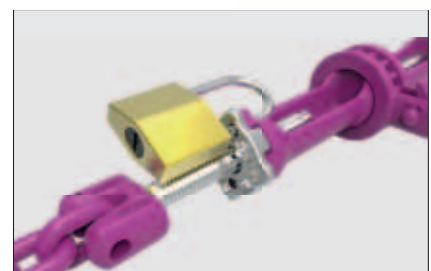

Securing disc with theft protection

Lashing chains not corresponding with DIN EN 12195-3 (since 7/2001 all over Europe) must not longer be sold!

Attention!

...important information!

ICE lashing chains fulfil the new standard on all items and furthermore offer a variety of additional features!

Regarding lashing chain standard EN 12195-3

Forbidden!



ICE Advantages!

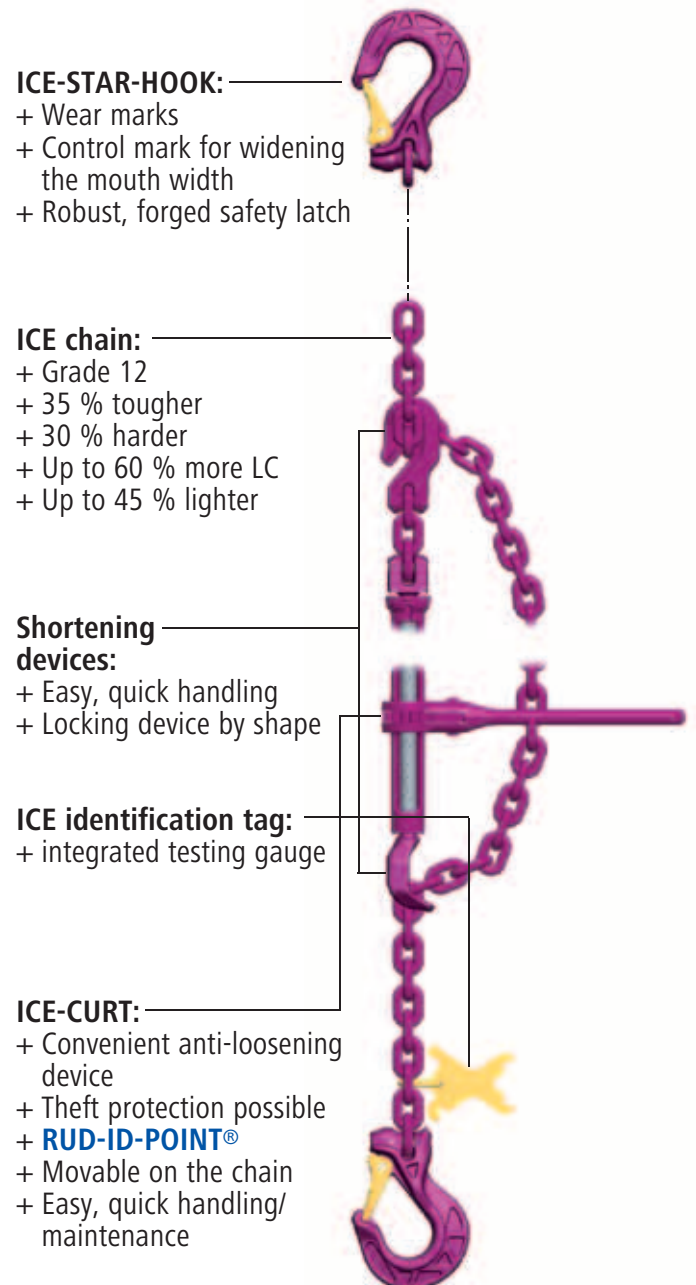
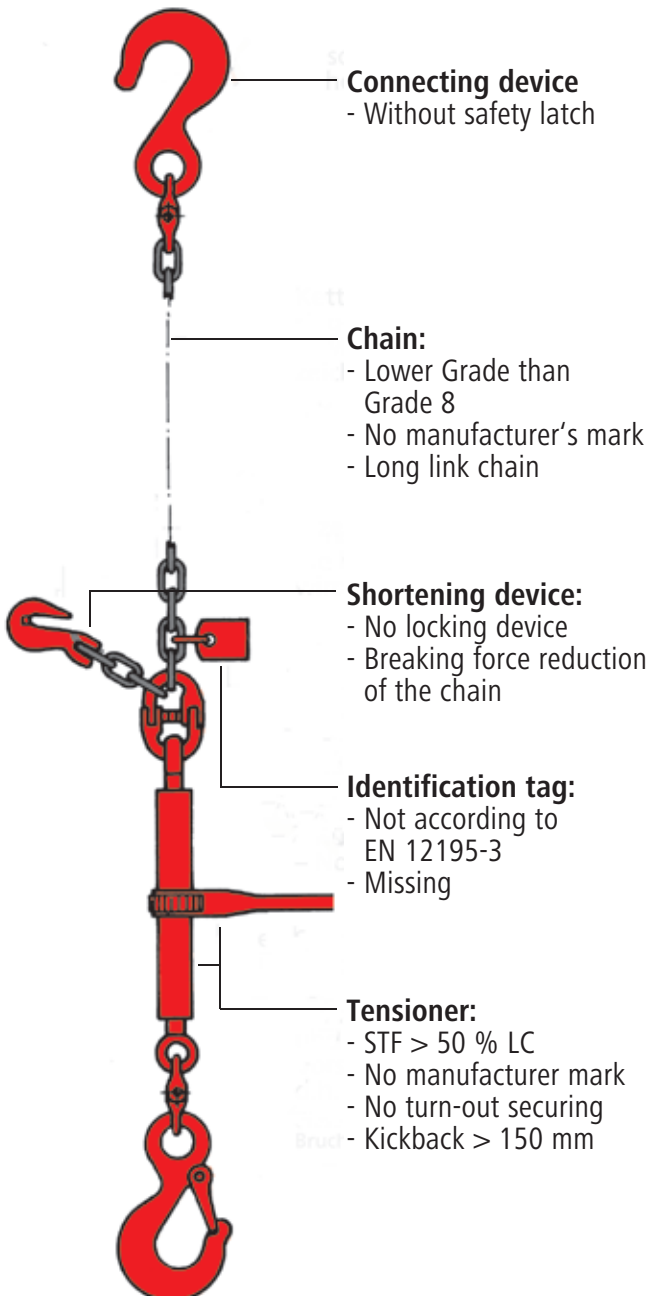



Lashing points

What will, however, be the use of the optimal calculation, the optimal lashing mean, if there suitable lifting- and lashing points at the load or on the vehicle have not been provided. Due to this fact, RUD has developed a complete range of high-tensile lifting- and lashing points. As the photos show, well known vehicle manufacturers already have successfully used these helpful devices. These are forged, moveable eyes made of high-quality alloy steel.

These elements have also been tested and approved by the BG for vehicles and the TÜV Rheinland (German authority for technical supervision).

In particular to mention is the new generation of lashing points with a clear LC indication in daN (see page 18-20).

These extremely practical elements can additionally be fit at the vehicle by approved welders. Besides to the lashing points ready to weld with LC indication there is a comprehensive assortment of variants ready to bolt which can be used for load securing. All geometry data are available free of charge on CD-ROM for the own CAD design.

Earth moving machineries such as excavators, loaders, dozers and special machines for earth moving have to be equipped with lashing points for assuring a safe transport. Also for a safe lifting, clearly marked lifting points have to be provided. They have been prescribed in EN 474-1 (earth moving machineries - safety) since 1994 for all new machines.

Trucks, trailers and semi-trailers with stake bodies have already been equipped since a certain time with lashing points for applying lashing means for load securing. For realisation it is referred to EN 12640 "Lashing points on commercial vehicles for goods transportation".



Load securing with heavy transports – we look forward to receiving your different kind of tasks!

One of the biggest problems with securing of heavy loads is how to avoid a static over-determination. This means if more than two lashing means are used for each direction, only two of the lashing means used accept the complete or the biggest part of the force. More than two strands will bear in theory if all of these strands fulfil the following conditions:

- same strand length
- same lashing angles
- same pre-tension
- same lashing mean (-elongation)

The practitioner immediately recognizes that such a load securing cannot be realized.

In order to solve this problem, you can draw on a trick: The lashing chains will be looped around and thus be lead in double strands from the load to the vehicle; the result will be four bearing strands in one direction.

Due to the loop, however, there must be a equation of the force in the double-strands. This can for example be effected by a looping around a round lifting bitt, as shown in the two photos above. An even better equation of force can be obtained by VIP lashing chains with a balancer roll.

Since with this "double lashing", different angles and specific individual conditions have to be respected besides to the common lashing angles α and β , this kind of load securing cannot be calculated in a common way.

Please let us have your specific task, we will find a solution!



Four bearing strands by VIP lashing chains with special balancer rolls

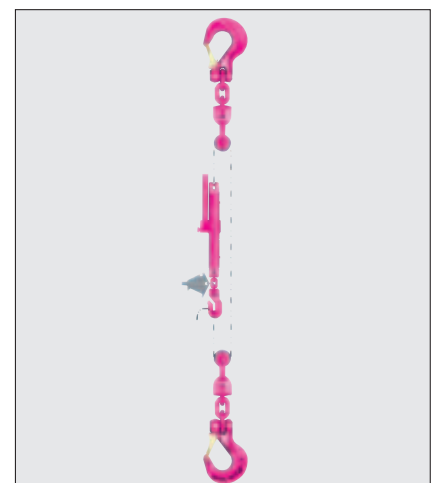
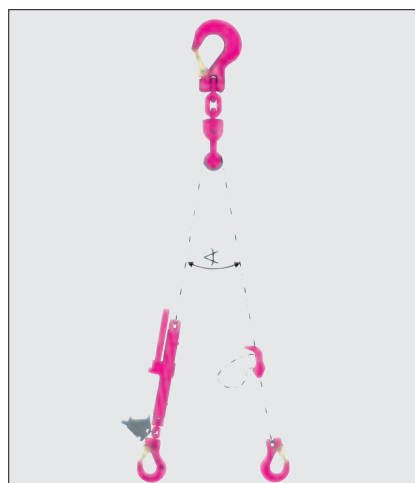

Container Lashing Chains for multi-bucket system vehicles

Optimal load securing on multi-bucket system vehicles!

You certainly do not consider collecting tickets resulting from missing load securing. However, the risk considerably increases with increasing traffic checks. By using RUD products, you can protect yourselves and at the same time increase the safety for yourselves and others on roads.

It is not sufficient to secure containers only by vertical lashing, e.g. Y-lashing as shown on the right-hand photo. With the presence of ice, oil, mud or dirt there can be a low friction value of about $\mu = 0.1$ even by using friction increasing mats.

The only safe variant is the inclined lashing such as V-, X- or trapeze lashing with fix connection at the lashing point and the suspension pin.

Attention: The load can slip when looping the chain through the lashing point, as it can often be seen with a V-lashing in practical use.

This means, however, that a tensioner has to be provided **at each lashing strand** – you should accept the slightly longer tensioning time in favour of the safety! The flatter the vertical angle α , the higher container weights can be transported – or a thinner chain can be used.



We recommend the following procedures:



▲ X-lashing

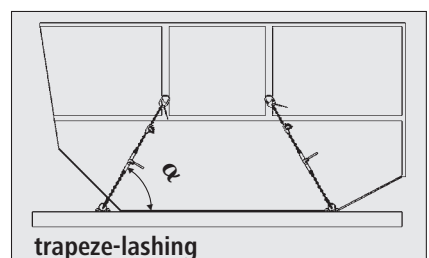
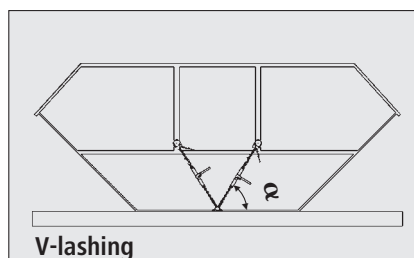



Example for multi-bucket system vehicles:

Load weight 15 t
 $\alpha = 60^\circ$
 Recommendation ICE chain with dia. 10 mm
 $\alpha = 30^\circ$
 A ICE chain with dia. 8 mm is sufficient.

The lateral securing has to be effected via a fix stop.

Prerequisite:

There must be proven lashing points at the vehicle suitable for accepting loads.

RUD container lashing chains allow a quick and easy direct lashing of the containers in and contrary to driving direction.

All components correspond with standard EN 12195-3.

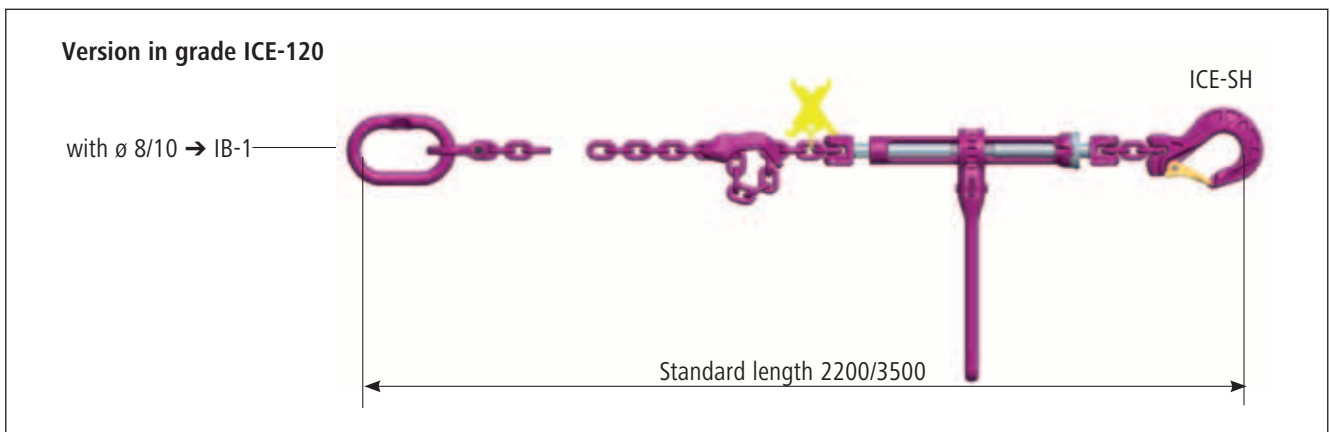
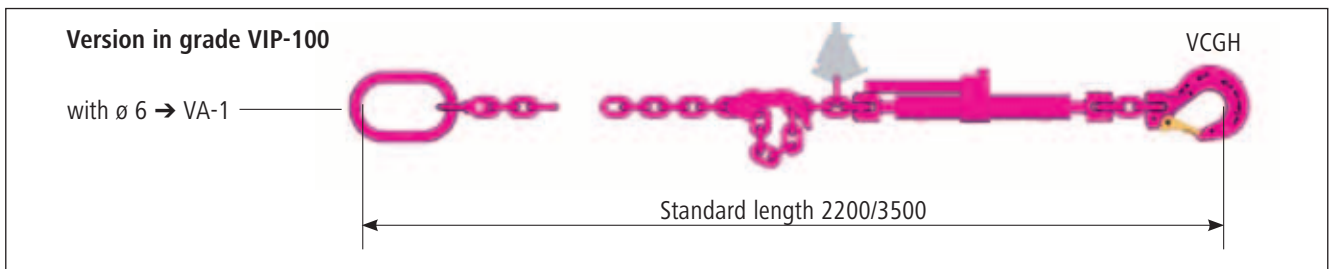

The pictures above exemplify the configuration of the RUD Container Lashing Chains. Other chain configurations analogue page 22/23 are also available. Please state the required chain configuration when ordering.

The right RUD Lashing Chain!

Grade	Chain \varnothing [mm]	LC per leg [daN]	Max. Container weight [t] (2 lashing chains per direction; $\mu = 0.1$; lateral form closure; $\beta = 0^\circ$)			Ref. no.
			$\alpha \leq 30^\circ$	$\alpha \leq 45^\circ$	$\alpha \leq 60^\circ$	
VIP-100	6*	3000	8.0	6.7	5.1	8600160
ICE-120	8	6000	16.0	13.5	10.2	8600261
ICE-120	10	10000	26.6	22.6	17.0	8600262

*Phase-out model – available as long as stock lasts.

Endless chains for missing or non adequate lashing points

A problem often occurring with direct lashing is the fact that no adequate lashing points are available at the load or the connection dimensions of the existing "lashing points" (often just holes) do not allow a correct attachment of the lashing hook.

Attention:

- The safety latch of the lashing hook should be closed in hooked-in condition!
- Lashing hook must only be loaded in the hook ground, never at the tip!

To adjust the lashing means to non adequate lashing points, the use of a shackle often causes problems since the shackles will be submitted to forbidden bending forces. An even better and especially flexible alternative is the endless chain (see adjacent photos).

A endless chain should be selected in the same nominal size and quality class as the lashing chain; thanks to the "doubling" of the chain, sharp edges at the endless chain will no longer represent a problem.

A special flexible endless chain can be generated by the ICE-Multi shortening claw, by just connecting a piece of ICE-chain with the ICE-Multi shortening claw to a closed loop.

Special advantages:

- The endless chain can be opened without tools and
- can be adjusted in its loop diameter.

Typical "direct lashing loads" without lashing points are stone blocks or concrete parts. By using an endless chain, a so-called "spring lashing" can be effected (adjacent photo).

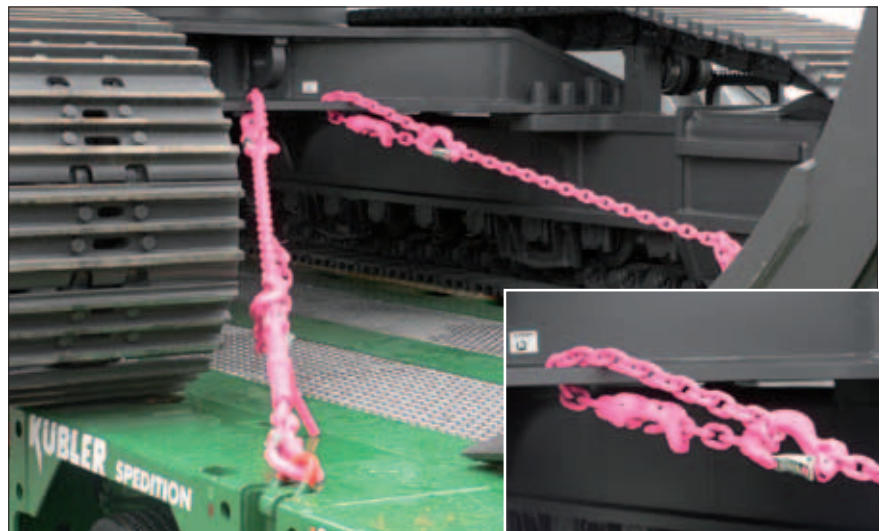

ICE-VSK-Endless chains grade ICE-120

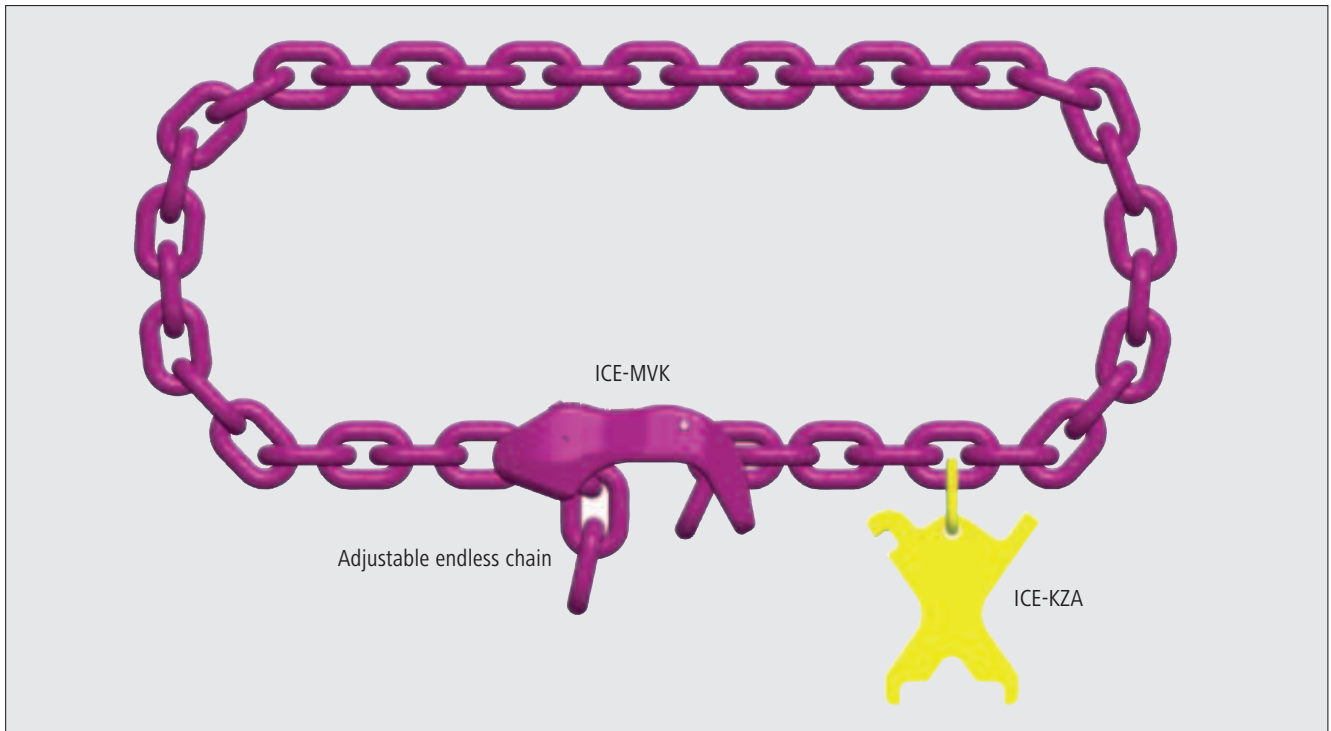

Chain Ø [mm]	Type	Lashing cap. LC [daN]	Chain length [m]	Weight [kg/pc.]	Ref. no.
6	ICE-VSK-KK-6	3600	1.0	1.2	7901307
8	ICE-VSK-KK-8	6000	1.2	2.5	7901308
10	ICE-VSK-KK-10	10000	1.2	4.2	7901309
13	ICE-VSK-KK-13	16000	1.5	8.8	7901310
16	ICE-VSK-KK-16	25000	1.5	13.4	7901311

Please mind the correct connection:

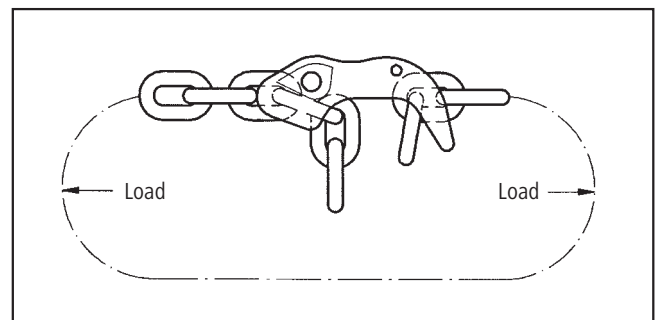
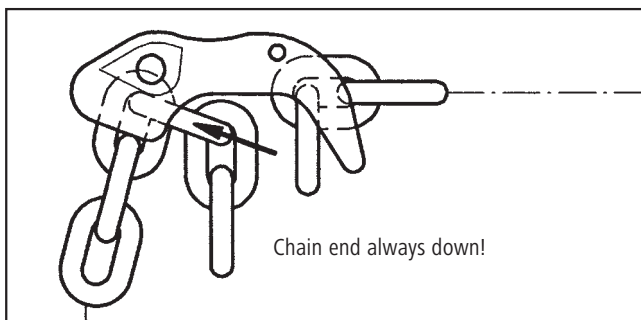



VIP Lashing Points with LC indication – weldable

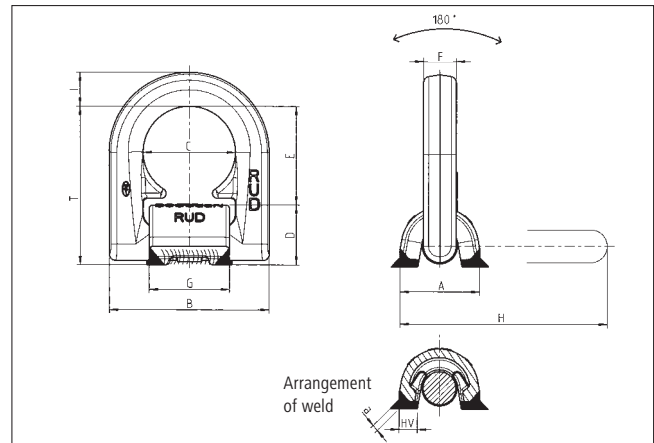

- Loadable from any direction
- Design in VIP quality, up to 50 % increased lashing capacity compared with standard design
- Shapely design, zinc-phosphated
- Inside spring for noise damping available
- The patented distance lugs assist in achieving the correct root weld.
- Optimized 90° load support - patented

Type	Lashing cap.											Weld HV + Δa	Weight [kg/pc.]	Ref. no.
	LC [daN]	A [mm]	B [mm]	C [mm]	D [mm]	E [mm]	F [mm]	G [mm]	H [mm]	I [mm]	T [mm]			
LPW-U 3000	3000	33	66	38	25	40	13.5	33	87	14	65	HV 5 + 3	0.35	7992225
LPW-U 5000	5000	36	77	45	27	48	13.5	40	97	16	75	HV 7 + 3	0.5	7994831
LPW-U 8000	8000	42	87	51	31	52	16.5	46	112	18	83	HV 8 + 3	0.8	7992226
LPW-U 13400	13400	61	115	67	44	73	22.5	60	157	24	117	HV 12 + 4	1.9	7992227
LPW-U 20000	20000	75	129	67	55	71	26.5	60	173	26.5	126	HV 16 + 4	2.9	7992228
LPW 32000	32000	95	190	100	69	105	26	90	243	40	174	HV 25 + 6	6.8	7992229

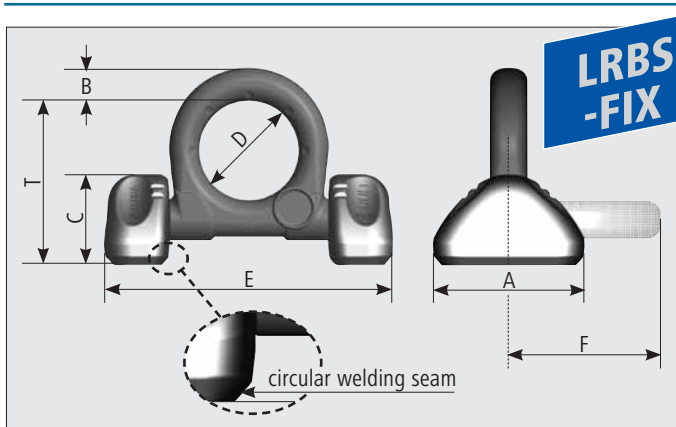

- Loadable from any direction
- Circular welding seam
 - No rusting under of the welding blocks
 - Smaller welding seam like LRBS
- Dimensions A, B, D, E, F like LRBS
- Welding blocks and ring body fix connected by special radial clamp spring
 - Easy adjustment of the ring body
 - Ring body stays in position
 - Easy painting
 - No loose parts
 - No rattling
 - Process reliability at welding: dimension E is assured
- Distance from ring body to weld contact area bigger than at LRBS
 - Easy painting in the gap

Type	LC [daN]	A [mm]	B [mm]	C [mm]	D [mm]	E [mm]	F [mm]	T [mm]	Weight [kg/pc.]	Ref. no.
LRBS-FIX 3000	3000	in preparation – soon available								
LRBS-FIX 5000	5000	in preparation – soon available								
LRBS-FIX 8000	8000	60	14	39	48	132	69	74	0.9	7999 303
LRBS-FIX 13400	13400	88	20	50	60	167	91	97	2.2	7999 304
LRBS-FIX 20000	20000	100	22	60	65	191	100	108	3.7	7999 305
LRBS-32000*	32000	130	30	72	90	267	134	140	8.0	7999 306

*Previous threepart design



VIP Lashing Points with LC indication – weldable

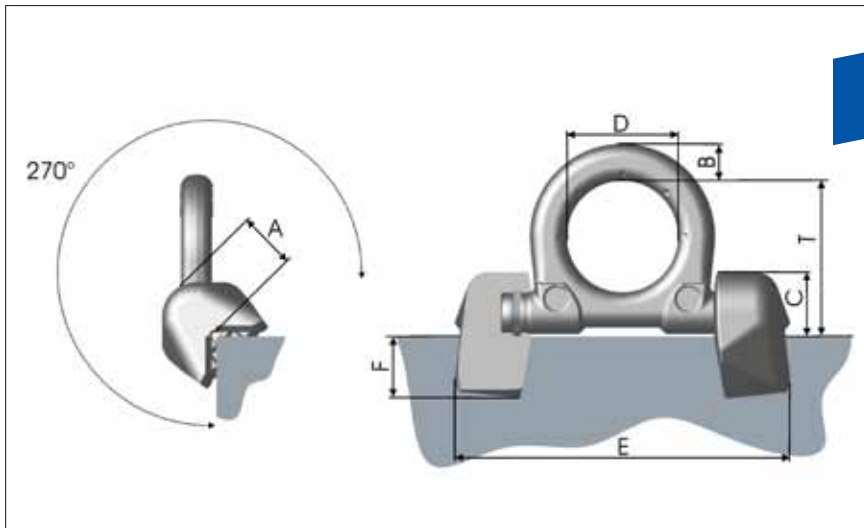

LRBK-FIX

New!

- Welded on the corner, it reduces the number of lashing points
- Loadable from any direction
- Low profile and 270° pivoting
- Welding blocks and ring body fix connected by special radial clamp spring
 - Easy adjustment of the ring body
 - Ring body stays in position
 - Easy painting
 - No loose parts
 - No rattling
 - Process reliability at welding: dimension E is assured

Type	LC [daN]	A [mm]	B [mm]	C [mm]	D [mm]	E [mm]	F [mm]	T [mm]	Weld	Weight [kg/pc.]	Ref.-No.
LRBK-FIX 8000	8000	32	14	28	48	141	29	65	HY 4+3	1	7903056
LRBK-FIX 13400	13400	40	20	35	60	181	33	84	HY 5+3	2.1	7903057
LRBK-FIX 20000	20000	52	22	46	65	212	46	94	HY 8+3	4.4	7903058

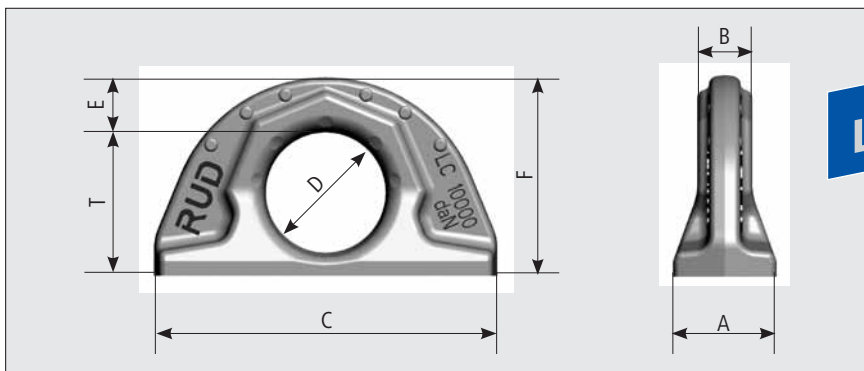

L-ABA

New!

- Loadable from any direction
- Quenched and tempered part, thereby wear resistant
- Patented wear markings inside and outside
- Small circular fillet weld seam
- No sharp edges

Type	LC [daN]	A [mm]	B [mm]	C [mm]	D [mm]	E [mm]	F [mm]	T [mm]	Weld	Weight [kg/pc.]	Ref.-No.
L-ABA 3200 daN	3200	30	16	100	35	16	57	41.5	4	0.44	7902667
L-ABA 6400 daN	6400	41	23	137	50	21	80	59	6	1.1	7902668
L-ABA 10000 daN	10000	51	27	172	60	27.5	99	71.5	7	2.3	7901722
L-ABA 20000 daN	20000	70	38	228	80	35	130	95	8	5.3	7901723



New!

VIP Lashing Points with LC indication – weldable

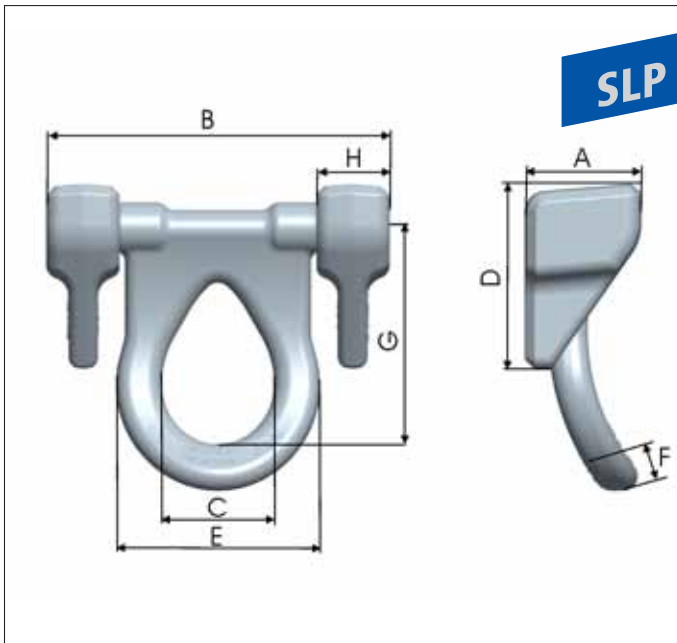

- Loadable from any direction
- Pivots 225°
- Lashing possible even at overhanging load
- No rusting under of the welding blocks
- Welding blocks and ring body fix connented by special radial clamp spring
 - Easy adjustment of the ring body
 - Ring body stays in position
 - Easy painting
 - No loose parts
 - No rattling
 - Process reliability at welding: dimension B is assured



Type	LC [daN]	A [mm]	B [mm]	C [mm]	D [mm]	E [mm]	F [mm]	G [mm]	H [mm]	Weight [kg]	Ref.-No. with spring
SLP 10000	10000	63	185	60	100	110	25	115	14	3.75	7900082





Combination – Lashing and Lifting Point

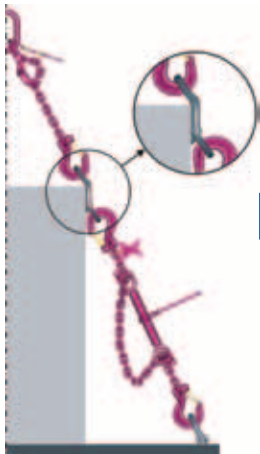

SMILEY BI

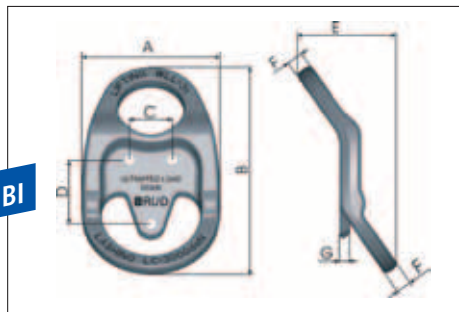

- Absolute innovative design
- Forged in one piece
- Noiseless – no rattling in the eyes
- Surface: galvanized
- Body and bolts 100 % crack detected
- Simple assembly with three bolts M12, quality 10.9
- Working Load Limit WLL marked in t
- Lashing Capacity LC marked in daN
- 4fold safety factor for lifting and lashing
- Suitable for all common lashing means – also for double connection

Type	WLL [t]	LC [daN]	A [mm]	B [mm]	C [mm]	D [mm]	E [mm]	F [mm]	G [mm]	3 x bolt	Weight [kg/pc.]	Ref. no. without bolts	Ref. no. with bolts
SMILEY-BI	3	3000	163	244	50	75	116	19	12	M12 x 30 Fk. 10.9	3.5/3.7	7997059	7997727

RORO Lashing Points

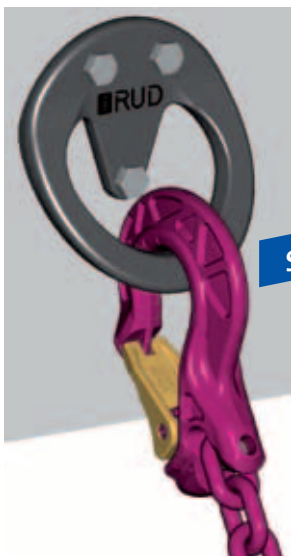

SMILEY

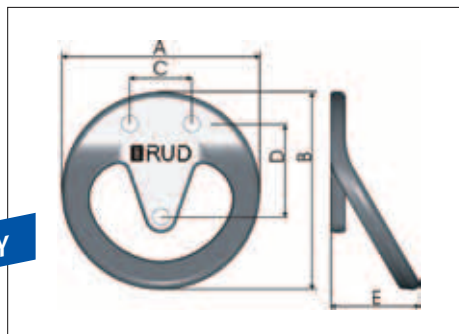

- Lashing- and connection device at road vehicles for sea transport on Ro/Ro ships
- Lashing point forged in one piece, noiseless
- 100 % crack detected
- acc. to EN 29367-2
Resistance characteristics with a proof force = 120 kN and a breaking force = 200 kN
- Simple attachment with three bolts M12, quality 10.9
- Surface: galvanized
- Shapely design, appropriate to the load
- Lightweight construction
- Suitable for all common lashing means – also for double connection
- The force contact point at the bracket has been chosen in such a way that the direction of load is in the centre of gravity of the bolts.
Advantage: Minimizing the load of the bolts, use of a smaller bolt dimension.

Type	-	LC [daN]	A [mm]	B [mm]	C [mm]	D [mm]	E [mm]	-	-	3 x bolt	Weight [kg/pc.]	Ref. no. without bolts	Ref. no. with bolts
SMILEY	-	6000	160	160	50	75	72	-	-	M12 x 30 Fk. 10.9	1.6/1.8	7994086	7997726

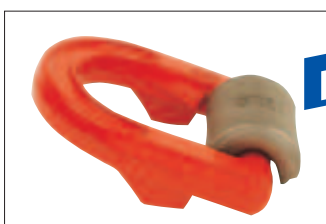

RORO

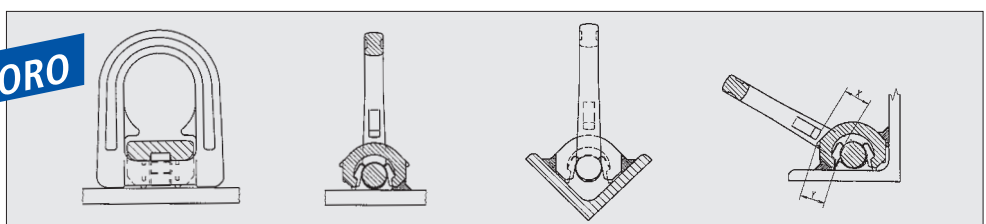

RORO Lashing point acc. to DIN EN 29367-2
Reference no. 7983031

Permissible lashing capacity = 10,000 daN.

ICE-VSK-CURT lashing chains – grade ICE-120

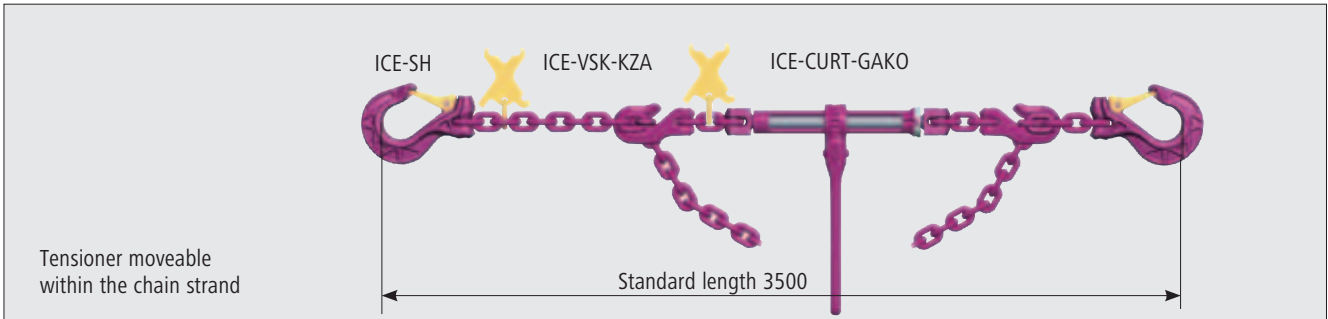

Chain Ø [mm]	Type	Lashing cap. LC [daN]	Type	Tensioner		Lmin [mm]	Weight [kg/pc.]	Ref. no.
				Pre-tension STF [daN]	Adjustm. [mm]			
6	ICE-VSK-6-CURT-IVH	3600	ICE-CURT-6-GAKO	in preparation – soon available				
8	ICE-VSK-8-CURT-IVH	6000	ICE-CURT-8-GAKO	2800	170	1040	8.0 + 5.2	7901 129
10	ICE-VSK-10-CURT-IVH	10000	ICE-CURT-10-GAKO	2800	170	1210	13.0 + 7.1	7901 130
13	ICE-VSK-13-CURT-IVH	16000	ICE-CURT-13-GAKO	2800	300	1600	21.9 + 13.6	7902 626
16	ICE-VSK-16-CURT-IVH	25000	ICE-CURT-16-GAKO	in preparation – soon available				

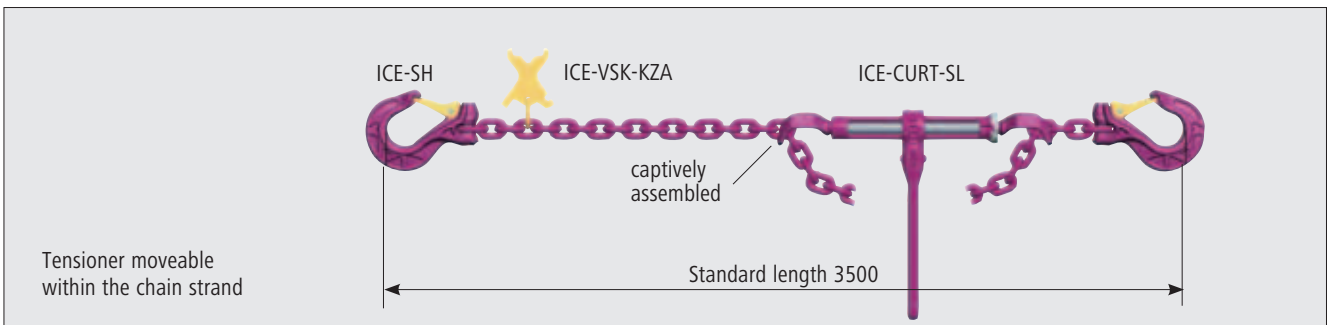

6	ICE-VSK-6-CURT-SL	3600	ICE-CURT-6-SL	in preparation – soon available				
8	ICE-VSK-8-CURT-SL	6000	ICE-CURT-8-SL	2800	170	817	12.6	7900 026
10	ICE-VSK-10-CURT-SL	10000	ICE-CURT-10-SL	2800	170	935	18.1	7900 027

VIP-VSK lashing chains – grade VIP-100

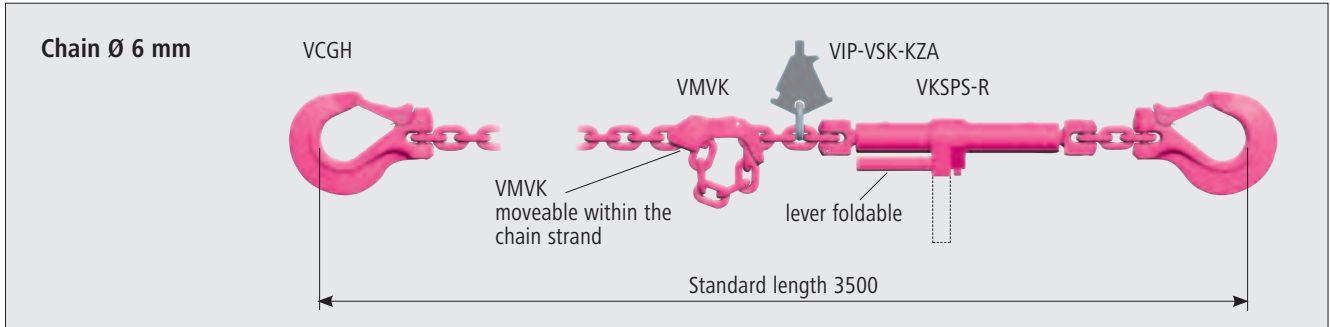

Chain Ø [mm]	Type	Lashing cap. LC [daN]	Type	Tensioner		Lmin [mm]	Weight [kg/pc.]	Ref. no.
				Pre-tension STF [daN]	Adjustm. [mm]			
6	VIP-VSK-6-VKSPS-VMK*	3000	VSKPS-6	1500	120	610	4.3	7900 029
6	VIP-VSK-6-VKSPS-R-VMK*	3000	VSKPS-R-6	1500	120	610	4.5	7900 030

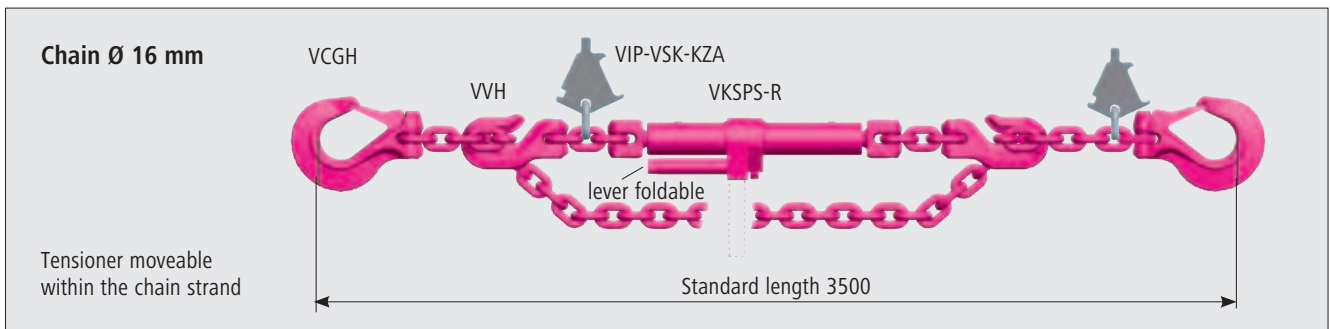

16	VIP-VSK-16-VKSPS-VVH*	20000	VSKPS-16	3600	300	1740	30.8 + 16.4	7900 031
16	VIP-VSK-16-VKSPS-R-VVH*	20000	VSKPS-R-16	3600	300	1740	30.8 + 16.9	7900 032

*Phase-out model – available as long as stock lasts.

Convenient tools



ICE-Identification tag as proof gauge (patent)

ICE-VSK-KZA	Ref. no. (with mounting link)
ICE-VSK-8	7995772
ICE-VSK-10	7995773
ICE-VSK-13	7995774



VIP-Identification tag as proof gauge (patent)

VIP-VSK-KZA	Ref. no. (with mounting link)
VIP-VSK-6	7988623
VIP-VSK-16	7988627

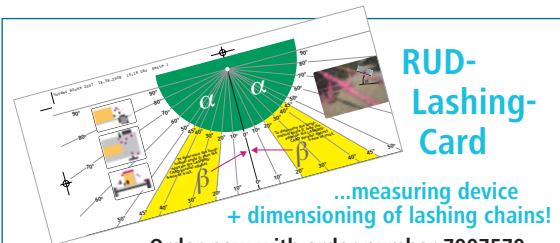

Order now with order number 7997579

Which lashing chain for which load? – Very easy with the RUD...

...CD-ROM!

Ref. no. 7982945



Which lashing chain for which load?

Diagonal lashing													
Lashing chain	LC [daN]	Max. load weight [t] (horizontal angle β : 20°-45°; 2 lashing chains per direction)											
		Vertical angle α : 0°-30°						Vertical angle α : 30°-60°					
		$\mu=0.1$	$\mu=0.2$	$\mu=0.3$	$\mu=0.4$	$\mu=0.5$	$\mu=0.6$	$\mu=0.1$	$\mu=0.2$	$\mu=0.3$	$\mu=0.4$	$\mu=0.5$	$\mu=0.6$
ICE-VSK 6	3600	6.2	8.4	10.4	13.0	17.4	26.2	4.5	6.3	9.0	12.8	19.2	32.0
VIP-VSK 6	3000	5.2	7.0	8.7	10.9	14.5	21.9	3.8	5.3	7.5	10.7	16.0	26.7
ICE-VSK 8	6000	10.5	14.0	17.4	21.8	29.1	43.9	7.6	10.7	15.0	21.4	32.0	53.4
ICE-VSK 10	10000	17.5	23.4	29.0	36.4	48.6	73.1	12.8	17.9	25.0	35.6	53.4	89.0
ICE-VSK 13	16000	28.0	37.5	46.4	58.2	77.8	117.0	20.5	28.6	40.0	57.1	85.5	142.4
VIP-VSK 16	20000	35.0	46.9	58.1	72.8	97.3	146.3	25.6	35.8	50.0	71.3	106.9	178.0

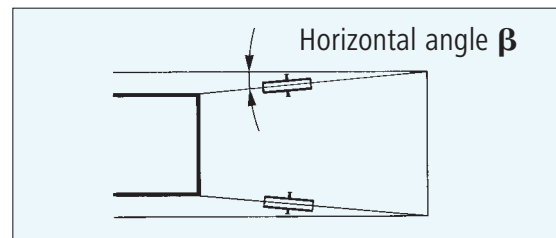
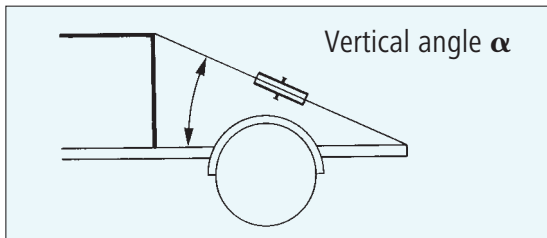

Frictional lashing													
RUD Lashing chain	STF [daN]	= required number of VIP + ICE lashing chains (number of lashing chains = factor from Table X load weight [t])											
		Vertical angle α : 60°-90°						Vertical angle α : 30°-60°					
		$\mu=0.1$	$\mu=0.2$	$\mu=0.3$	$\mu=0.4$	$\mu=0.5$	$\mu=0.6$	$\mu=0.1$	$\mu=0.2$	$\mu=0.3$	$\mu=0.4$	$\mu=0.5$	$\mu=0.6$
VIP-VSK 6	1500	3.6 x	1.6 x	0.9 x	0.6 x	0.4 x	0.2 x	6.3 x	2.7 x	1.5 x	0.9 x	0.6 x	0.3 x
VIP-VSK 8	2500	2.2 x	1.0 x	0.6 x	0.4 x	0.2 x	0.2 x	3.8 x	1.6 x	0.9 x	0.6 x	0.4 x	0.2 x
VIP-VSK 10	2800	2.0 x	0.9 x	0.5 x	0.3 x	0.2 x	0.1 x	3.4 x	1.5 x	0.8 x	0.5 x	0.3 x	0.2 x
ICE-VSK 8/10/13	2800	2.0 x	0.9 x	0.5 x	0.3 x	0.2 x	0.1 x	3.4 x	1.5 x	0.8 x	0.5 x	0.3 x	0.2 x
VIP-VSK 13/16	3600	1.5 x	0.7 x	0.4 x	0.3 x	0.2 x	0.1 x	2.6 x	1.2 x	0.7 x	0.4 x	0.3 x	0.2

Values of both tables refer to: stable load, road transport, no combination with other lashing or securing methods!

Slide-coefficient of friction μ acc. to VDI 2700-2			
Materials	dry	wet	greasy
Wood/wood	0.20-0.50	0.20-0.25	0.05-0.15
Metal/wood	0.20-0.50	0.20-0.25	0.02-0.10
Metal/metal	0.10-0.25	0.10-0.20	0.01-0.10

If there is a clear deviation from the indicated lashing angles, then it is necessary to add some safety measures (e.g. larger chain diameter, and/ or chocks – friction increasing elements).



Heavy construction machinery should be positioned bucket first, tight against the step frame of the low loader.

Handbrake must be engaged and the vehicle left in gear.

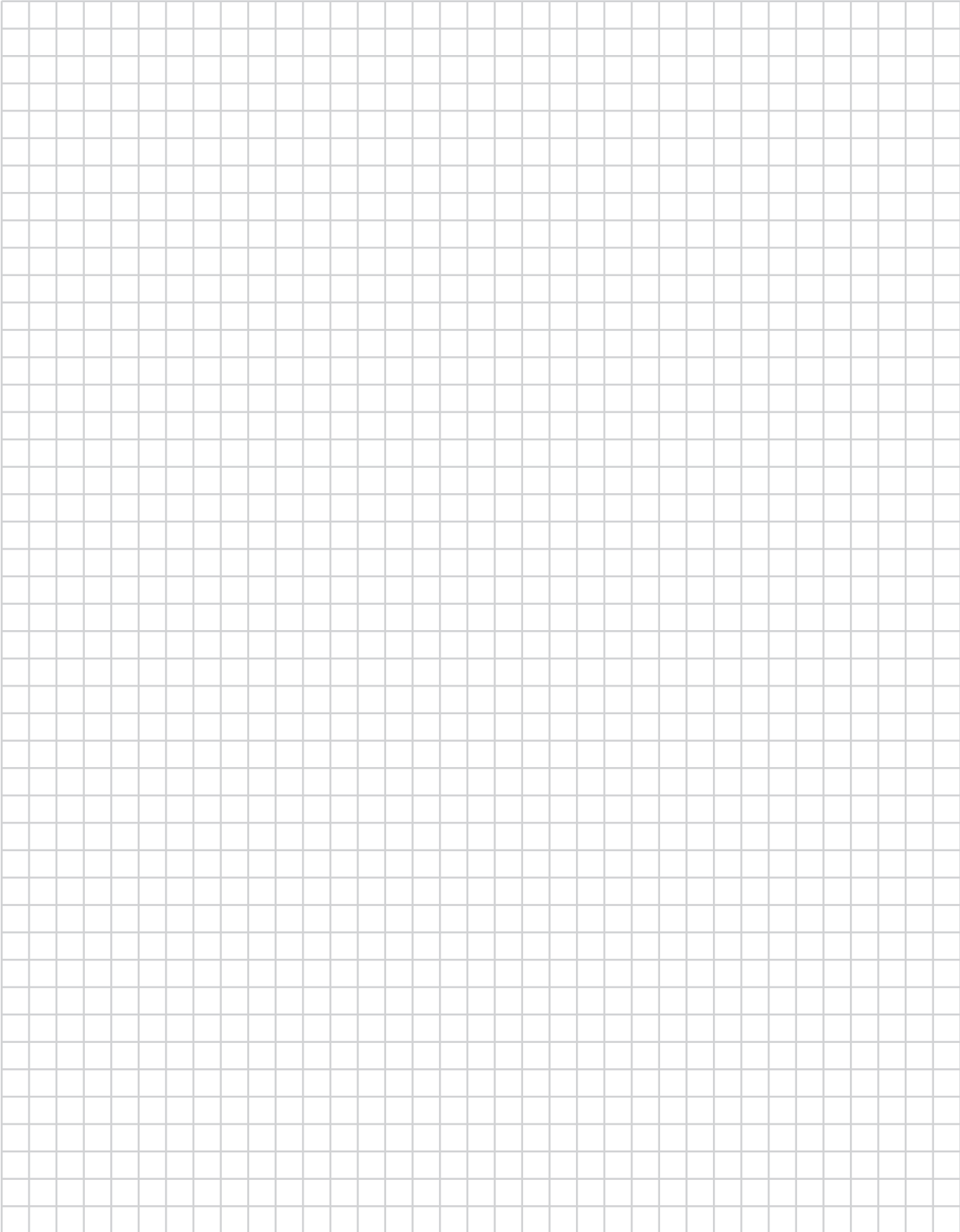



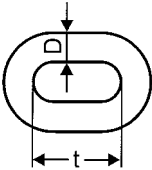

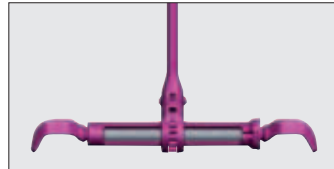
For notes

A large grid of small squares, intended for taking notes. The grid consists of 20 columns and 30 rows of squares.

Comparison of rules for lashing chains – example round steel link chain 8 mm

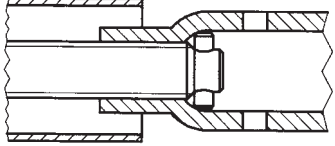
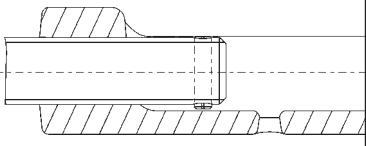
No.	Heading	Customary before 2001	EN 12195-3	Grade ICE-120
1	Chain quality	Grade 2 to 8 e.g. LC of 500 daN up to 4000 daN	EN-818-2 grade 8 – 800 N/mm ² e.g. LC = 4000 daN .	Special quality BG cert. 60 % increased breaking force grade 12 – 1200 N/mm ² e.g. LC = 6000 daN
1.1	Chain Dimensions	Different pitch lengths 	$t = 3 \times D$ (for transport of long wood $t = 6 \times D$ allowed)	$t = 3 \times D = 8 \times 24$
1.2	Chain identification	Not defined	+ manufacturer's identification + 8 for grade 8	ICE Pink powder coating ICE-identification: every chain link ICE-marked and $\text{\textcircled{D}}$ -12-marked in regular intervals.
2	Minimum breaking force	No standard. By insufficient shortening means, reductions of up to 40 % could have been possible e.g. BF = 48 KN instead of 80 KN with Grade 8!	In shortened condition minimum breaking strength must be achieved. 100 %! e.g. BF = 80 KN	100 % in shortened condition. e.g. BF = 120 KN
2.1	Shortening	Chain killer. Reduction of the breaking force up to 40 % 	100 % of breaking force must be proven	ICE shortener fulfils 100 % 
3	Proof load	Deformation with 1.25 LC at chain and tensioner were common. No requirement	No deformation at LC x 1.25 – Load period 1 min.	No deformation at LC x 1.25 – 1 min.
4	Tensioning element	Turnbuckles; tensioners with long levers; elbow lever- or excenter tensioners with kickback > 150 mm No-name-products	Only tensioners with a kickback at the end of the tensioning lever being smaller than 150 mm. Manufacturer identification is compulsory.	ICE-T-Ratchet tensioner – no kickback. 
4.1	Securing of pre-tension	No rule in case of vibrations, loosening could occur	No unintentional loosening of pre-tension (safety chain or similar)	Ratchet tensioner with novel, convenient anti-loosening-device (see page 10)

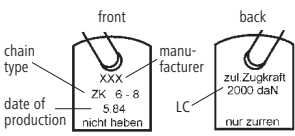
Comparison of rules for lashing chains – example round steel link chain 8 mm

No.	Heading	Customary before 2001	EN 12195-3	Grade ICE-120
4.2	Tension force STF <div style="border: 1px solid black; padding: 2px; display: inline-block;">50 daN</div> 	No rule. Ratchet tensioner with extremely long lever and insufficient shortening elements achieve a STF up to 65 % of the breaking force e.g. STF = 5200 daN = 1.3 x LC = 65 % BF! Not allowed!	STF = remaining force in the lashing (pre-tension) after a standard-hand force (SHF) of 500 N (50 daN) at the lever of the tensioner. At \varnothing 6 - 10 mm: $STF_{min} = 0.25 \times LC$ $STF_{max} = 0.5 \times LC$ At \varnothing 13 - 16 mm: $STF_{min} = 0.15 \times LC$ $STF_{max} = 0.5 \times LC$	ICE-Ratchet tensioner – STF \varnothing 8: 2800 daN = 0.46 LC \varnothing 10: 2800 daN = 0.28 LC \varnothing 13: 2800 daN = 0.17 LC
4.3	Tensioning element Turn-out securing 	No rule. An unintentional loosening of spindles insufficiently screwed was often occurred.	Turn-out securing compulsory. 	Turn-out securing at ratchet tensioners. 
4.4	Tensioning elements with hook-shaped shortening devices	No rule. Easy drop out often occurred Refer to item 2.1. oder Verriegelung.	Securing by shape or locking device.	ICE shortener with securing by shape.
5	Unintentional turn out at connection elements (hooks)	Insufficient!	Safety latch compulsory.	Robust safety latch compulsory. 
6	Identification of the complete lashing chain	Non, respectively acc. to VDI 2701.  Hint: not for lifting, just lashing!	Indications extended: <ul style="list-style-type: none"> ● Lashing force (LC) [daN] ● Tension force (STF) [daN] ● Name of manufacturer ● Indication of standard ● Hint: not for lifting 	<ul style="list-style-type: none"> ● Patented identification tag fulfils standard prescriptions and allows an easy examination of the chain. ● Distinctive identification by a  RUD-ID-Point® embedded into the tensioner.

Useful hints for the user:

RUD-CD-ROM or www.rud.com

New!
3D-CAD
Files



The user can easily choose the correct RUD sling chain and lifting points by only a mouse click!

With lashing chain calculation program and lashing protocol!

Based upon a questionnaire, the most important data are entered such as e.g.

- weight of load
- horizontal- and vertical angle
- sliding friction value

The optimal RUD lashing chain will automatically be determined in only a few seconds. You can print out: drawing scheme, parts list and calculation protocol of the selected RUD lashing chain!

Reference no. 7982945

